

FIREXPIRE™ RE-ASSEMBLY AND MAINTENANCE

(Topsy 2000)

Please note: Firexpire is an effective low cost auxiliary device and must never replace primary fire prevention measures. Obstructions preventing the plate from dropping may adversely affect the function of the unit, and as many Firexpire devices are used in unsupervised locations, regular inspection and immediate replacement of any damaged or distorted components is essential.

HOW IT WORKS

The Firexpire system includes three important components.

1. Central Spacer
2. Firexpire extinguishing plate
3. Thermoplastic trigger washer
4. Panhead screw

Firexpire works by having a plate suspended above aperture height secured by a panhead screw and a thermoplastic trigger washer. When a fire occurs inside the liner, the thermoplastic washer responds by releasing the Firexpire plate. This then drops onto the liner sealing and starving the fire within of oxygen, thus snuffing out the fire.

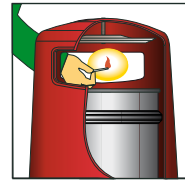

STAGE 1
A burning match is carelessly discarded into a litter bin.

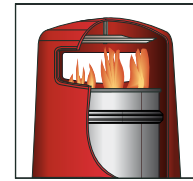

STAGE 2
The fire takes hold.

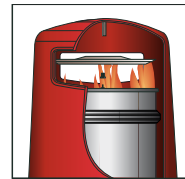

STAGE 3
In under a minute, the fire extinguishing plate drops onto the liner.

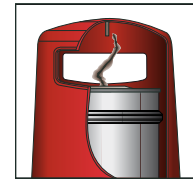

STAGE 4
The fire is contained.

INSTRUCTIONS TO REPLACE TRIGGER IF A FIRE HAS ACTIVATED THE FIREXPIRE PLATE.

Stubber Plate
Carrier
Bin Hood
Central Spacer
Wires
Firexpire Extinguishing Plate

Thermoplastic Trigger Washer
Panhead Screw

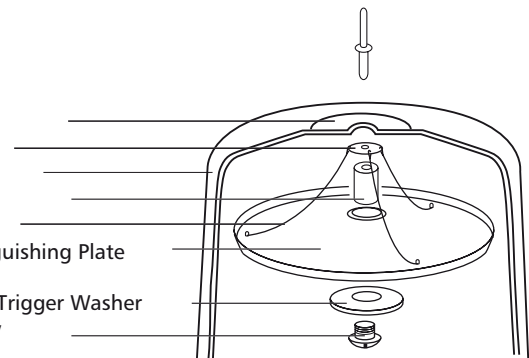

- 1** After first ensuring the Firexpire Plate is cool and the contents of the Liner compartment have been extinguished, remove the top section of the litter bin and turn the Hood upside down.

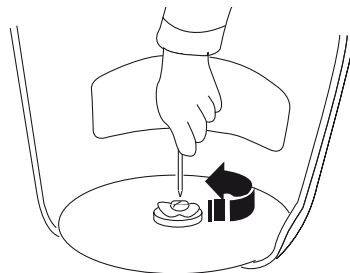

- 2** Using a screw driver, unscrew the Panhead Screw and Thermoplastic Washer (which will now be deformed) from the Central Spacer. Remove and discard the deformed Thermoplastic Trigger Washer from the Panhead Screw.

- 3** Insert the threaded Panhead Screw through a replacement Thermoplastic Trigger Washer.

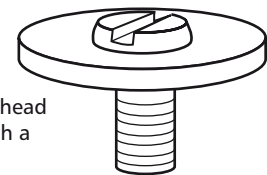

- 4** Locate Extinguishing Plate into position over the Central Spacer.

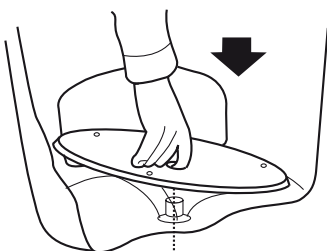

- 5** Locate Panhead Screw and Trigger Washer together into the Central Spacer.

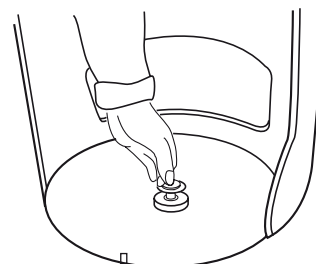

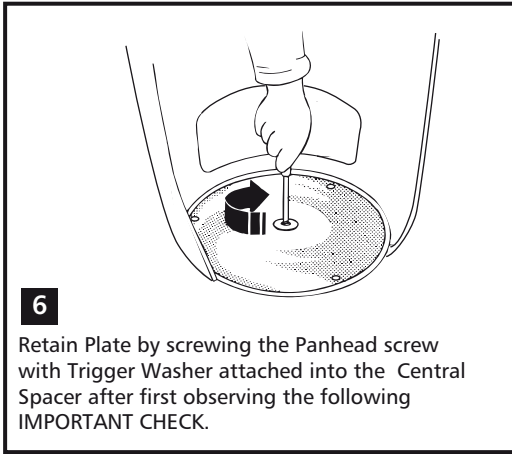

IMPORTANT CHECK

Ensure Fireproof Plate is absolutely central before tightening

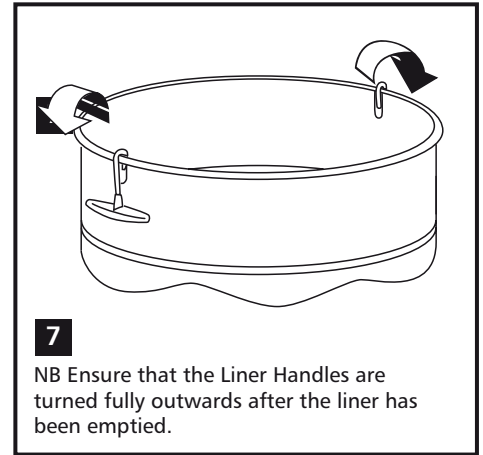

- A planned maintenance schedule of regular inspection is recommended, replacing components as necessary.
- Replacement components are available direct from GLASDON.
- GLASDON cannot be held responsible for claims arising from incorrect installation, unauthorised modifications or misuse of the product.

 Glasdon® AND FIREPIRE™ ARE TRADEMARKS OR REGISTERED TRADEMARKS OF GLASDON GROUP OR ITS SUBSIDIARIES IN THE U.K. AND OTHER COUNTRIES

Issue 2 June 2005 Stock no. 000/0205 Page 2 of 2

© Glasdon June 2005. Glasdon reserve the right to alter price and specification without prior notice.



Glasdon

Glasdon U.K. Limited
Preston New Road
BLACKPOOL
Lancashire
FY4 4UL

Telephone: 01253 600410
Fax: 01253 792558
e-mail: sales@glasdon-uk.co.uk
web: www.glasdon.com